

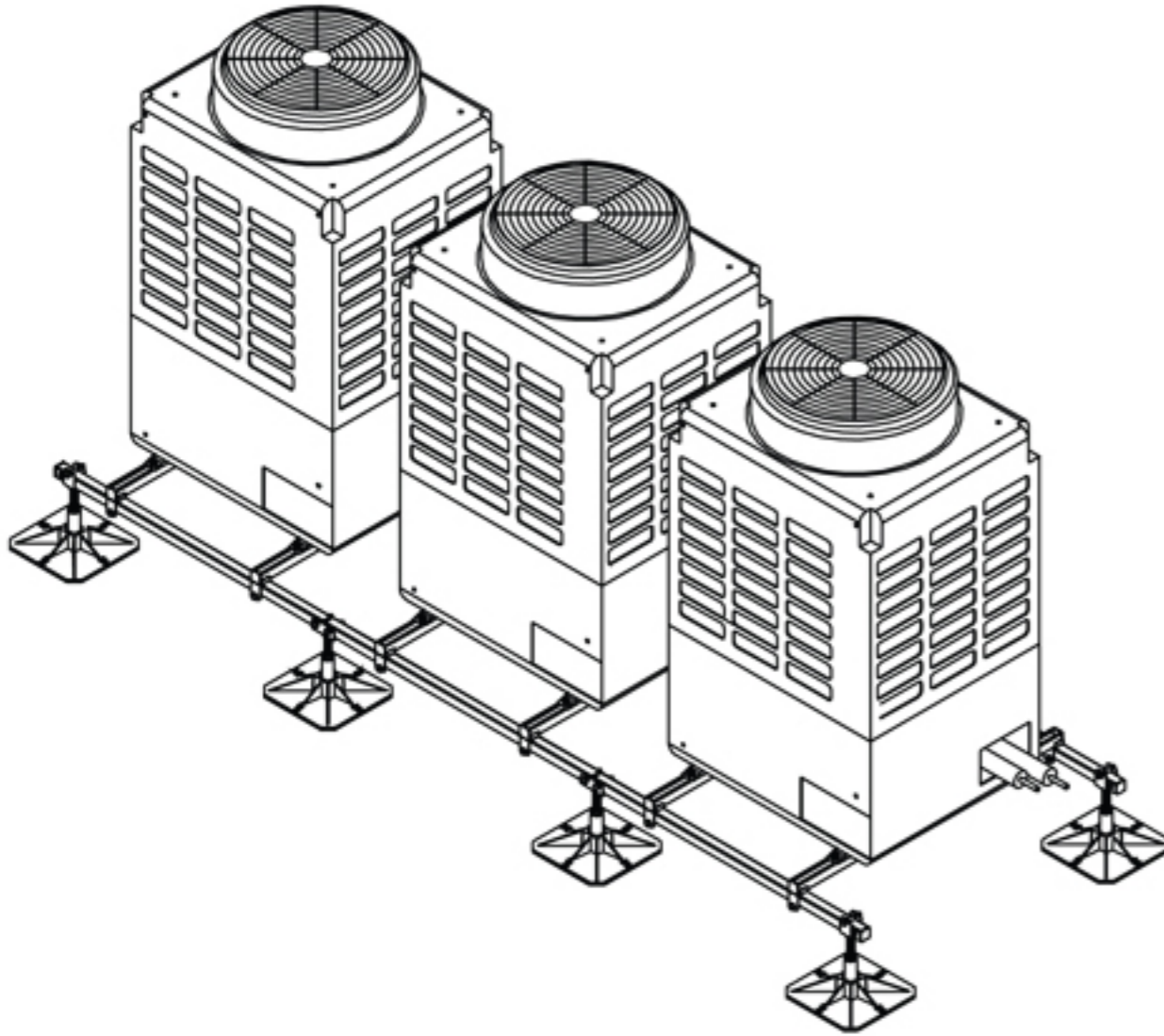

light

# Flexi Light - Flexi Frame

## Modular Frames for VRV/VRF Systems



### Features & Benefits

- Non-penetrative support
- Flexible design to accommodate late design changes
- Fast and simple installation
- Hot dip galvanised frameworks
- No time consuming clamping kits required, cross bars are industry standard strut fix
- Full AutoCAD drawing support
- Load management and wind calculations available
- Full on-site support and surveying services
- Available as standard 320mm square foot or 500mm option for heavy duty applications



Pump House  
 Glaisdale Drive East  
 Nottingham  
 NG8 4LY  
 Tel: +44(0)115 900 5858  
[www.flexisupportsystems.co.uk](http://www.flexisupportsystems.co.uk)  
[sales@flexisupportsystems.co.uk](mailto:sales@flexisupportsystems.co.uk)



everyday

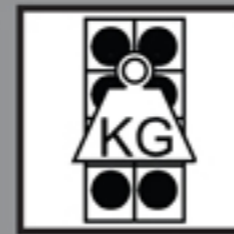

heavy



solar



access



# Flexi Modular Frames for VRV/VRF Systems

These versatile free standing frameworks are supplied boxed and come with fully adjustable leg assemblies with 320mm square black polypropylene feet as standard\*, incorporating anti-vibration rubber mats adhered to the underside. Robust 40 x 40mm standard box end bars are 3mm thick and leg assemblies can slide to many positions. Industry standard strut cross bars negate the requirements of time consuming clamping kits as sprung washers and associated M10 fixings are supplied with all frameworks. For heavier services please visit our 'flexi - heavy' range.

\* 500mm square foot option for heavy duty applications

## Typical VRV/VRF System layout

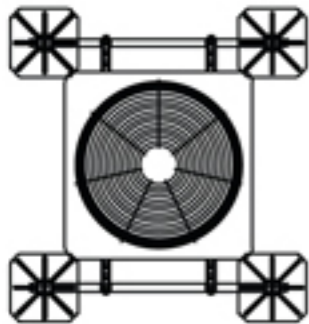
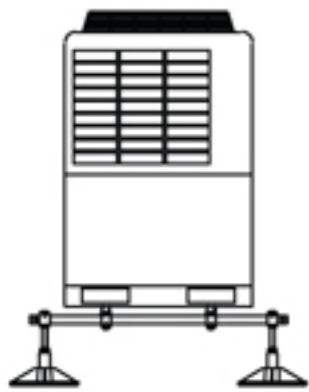

Part Code PH-BF-B

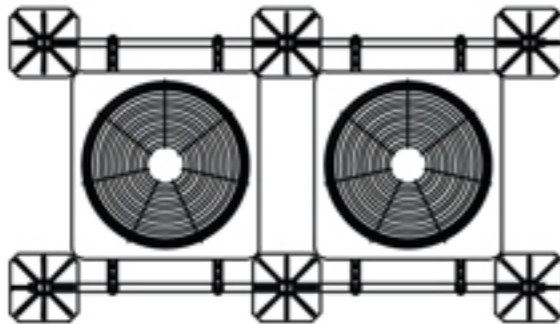
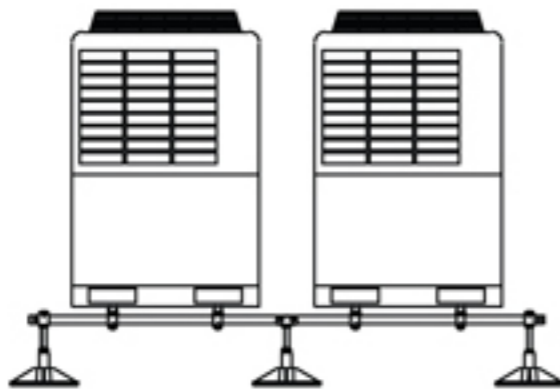

Part Codes PH-BF-B + PH-EF-B

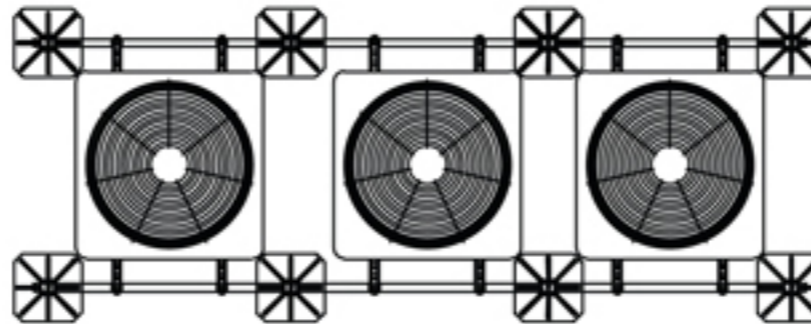
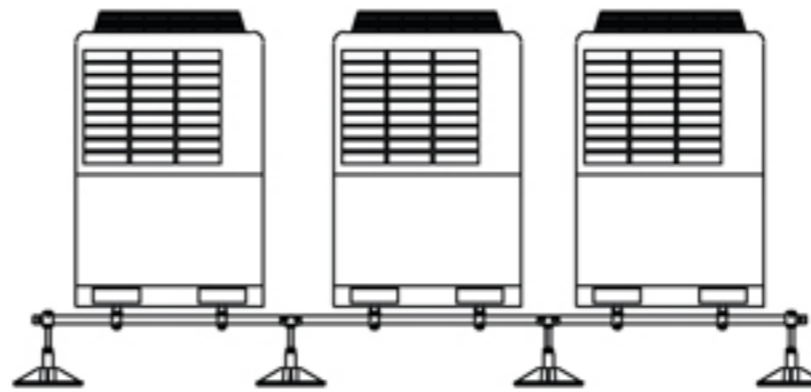

Part Code: PH-BF-B + 2 X PH-EF-B

Code	Description	Length	Width	Min. Height	Max. Height	Safe Working Load**	Weight
PH-BF-B	Flexi Base Frame	1200mm	1200mm	300mm	405mm	500kg	30kg
PH-EF-B	Flexi Extender Frame	1200mm	1200mm	300mm	405mm	500kg	24kg

The system can accommodate any number of VRV/VRF Units by simply adding additional PH-EF-B (Extender Frames)



## Specification Extract

External VRV/VRF services will be supported on Pump House fully adjustable and hot dip galvanised flexi frames. Contact Pump House Tel: +44(0)115 900 5858.

## Application

Suitable for VRV/VRF systems, cross bars slide to accommodate VRF fixing feet centres and negate the requirement of time consuming clamping kits (as seen with some systems), as industry standard sprung nuts and strut cross bars provide a very fast install.

## Material Specification

- Foot - 320mm square as standard or 500mm square for heavy duty applications UV stabilised 90% polypropylene, 10% grp
- Mat - 100% natural rubber, (mat is adhered to the foot)
- Legs - 48mm dia. 3mm steel tube with M24 stud adjuster and 3mm thick U-clevis to top
- End bars - 40x40x3mm SHS (square hollow section)
- Cross bars - 41x41x2.5mm slotted stut with adjustable end clamps
- Finish - Hot dip galvanised steelwork BS EN 10219-1:2006.  
Galvanising: BS EN ISO 1461:2009  
Salt Mist Testing: BS EN IEC 60068-2-52:2018

## Our Service Offers You

- Quotations on request
- Full AutoCAD drawings support
- Site support and site surveys
- Load management calculations
- Over 20 years experience in flat roof design and providing support systems to building services
- Fast delivery (FREE on large orders)
- Experienced in-house technical staff